

Please check the examination details below before entering your candidate information

Candidate surname

Mr. Demerdash

Other names

**Pearson Edexcel
International GCSE**

Centre Number

--	--	--	--	--

Candidate Number

--	--	--	--

Monday 7 January 2019

Morning (Time: 2 hours)

Paper Reference **4MA1/1H**

Mathematics A

Level 1/2

Paper 1H

Higher Tier



You must have:

Ruler graduated in centimetres and millimetres, protractor, compasses, pen, HB pencil, eraser, calculator. Tracing paper may be used.

Total Marks

Instructions

- Use **black** ink or ball-point pen.
- **Fill in the boxes** at the top of this page with your name, centre number and candidate number.
- Answer **all** questions.
- Without sufficient working, correct answers may be awarded no marks.
- Answer the questions in the spaces provided
– *there may be more space than you need.*
- **Calculators may be used.**
- You must **NOT** write anything on the formulae page.
Anything you write on the formulae page will gain **NO** credit.

Information

- The total mark for this paper is 100.
- The marks for **each** question are shown in brackets
– *use this as a guide as to how much time to spend on each question.*

Advice

- Read each question carefully before you start to answer it.
- Check your answers if you have time at the end.

Turn over ►

P59017A

©2019 Pearson Education Ltd.

1/1/1/1



P 5 9 0 1 7 A 0 1 2 8



Pearson

International GCSE Mathematics
Formulae sheet – Higher Tier

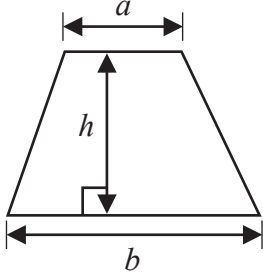
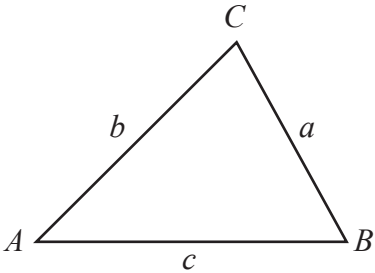
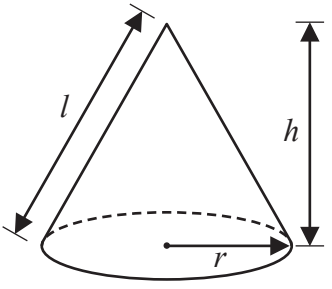
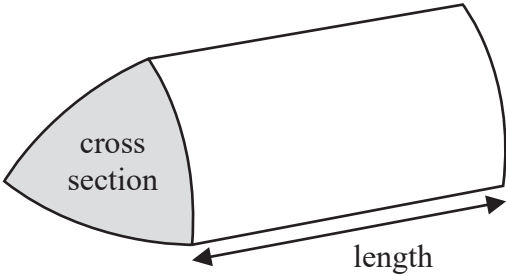
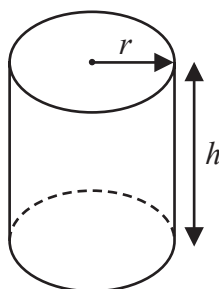
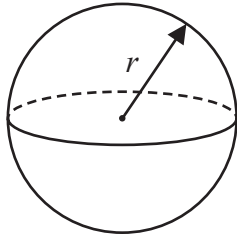
<p>Arithmetic series</p> <p>Sum to n terms, $S_n = \frac{n}{2} [2a + (n - 1)d]$</p>	<p>Area of trapezium = $\frac{1}{2}(a + b)h$</p>
<p>The quadratic equation</p> <p>The solutions of $ax^2 + bx + c = 0$ where $a \neq 0$ are given by:</p> $x = \frac{-b \pm \sqrt{b^2 - 4ac}}{2a}$	
<p>Trigonometry</p> 	<p>In any triangle ABC</p> <p>Sine Rule $\frac{a}{\sin A} = \frac{b}{\sin B} = \frac{c}{\sin C}$</p> <p>Cosine Rule $a^2 = b^2 + c^2 - 2bc \cos A$</p> <p>Area of triangle = $\frac{1}{2}ab \sin C$</p>
<p>Volume of cone = $\frac{1}{3} \pi r^2 h$</p> <p>Curved surface area of cone = $\pi r l$</p> 	<p>Volume of prism = area of cross section \times length</p> 
<p>Volume of cylinder = $\pi r^2 h$</p> <p>Curved surface area of cylinder = $2\pi r h$</p> 	<p>Volume of sphere = $\frac{4}{3} \pi r^3$</p> <p>Surface area of sphere = $4\pi r^2$</p> 

DO NOT WRITE IN THIS AREA

DO NOT WRITE IN THIS AREA

DO NOT WRITE IN THIS AREA

DO NOT WRITE IN THIS AREA

DO NOT WRITE IN THIS AREA

DO NOT WRITE IN THIS AREA



Answer ALL TWENTY ONE questions.

Write your answers in the spaces provided.

You must write down all the stages in your working.

1 (a) Factorise fully $4p + 6pq$

(2)

(b) Expand and simplify $(e + 3)(e - 5)$

(2)

(c) Solve $y = \frac{2y + 1}{5}$

Show clear algebraic working.

$y =$

(3)

(Total for Question 1 is 7 marks)



2

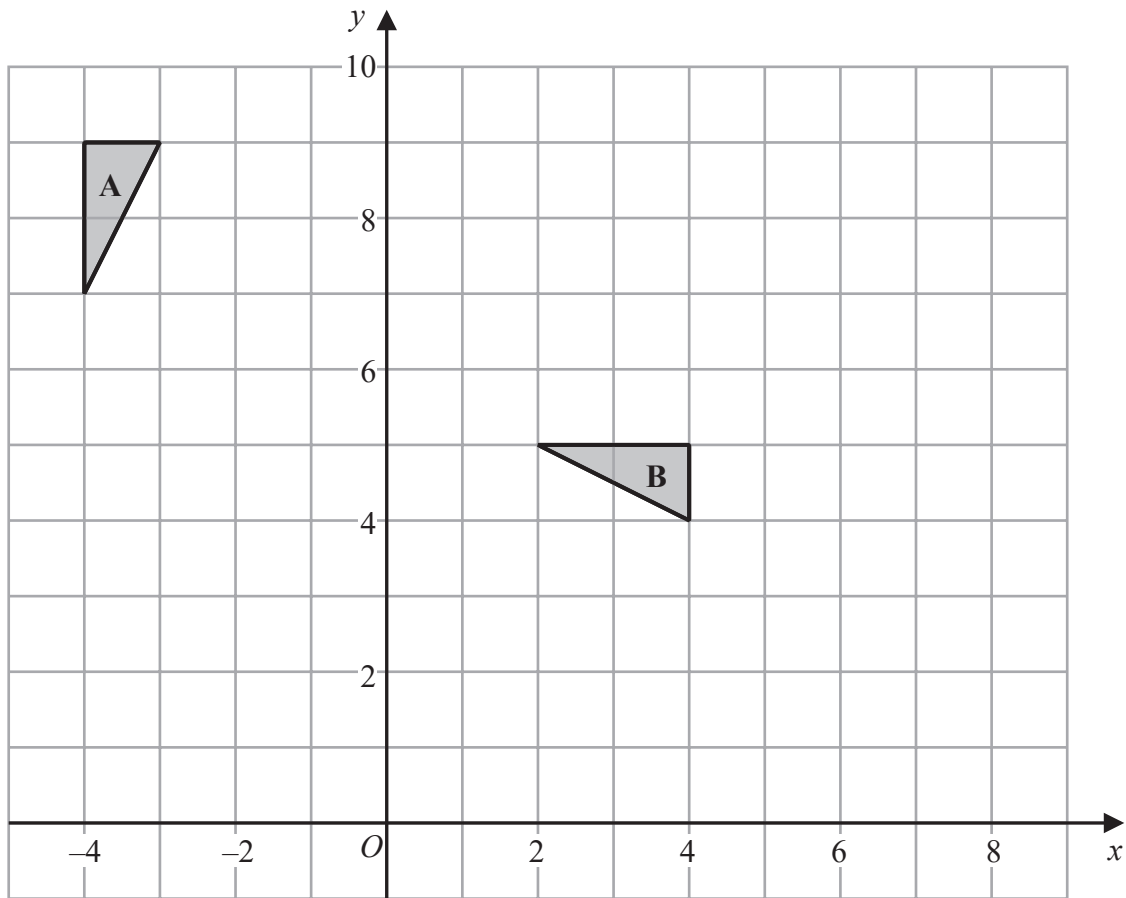

(a) Describe fully the single transformation that maps triangle **A** onto triangle **B**.

(3)

(b) On the grid, translate triangle **A** by the vector $\begin{pmatrix} 2 \\ -5 \end{pmatrix}$
Label the new triangle **C**.

(1)

DO NOT WRITE IN THIS AREA

DO NOT WRITE IN THIS AREA

DO NOT WRITE IN THIS AREA

DO NOT WRITE IN THIS AREA

DO NOT WRITE IN THIS AREA

DO NOT WRITE IN THIS AREA



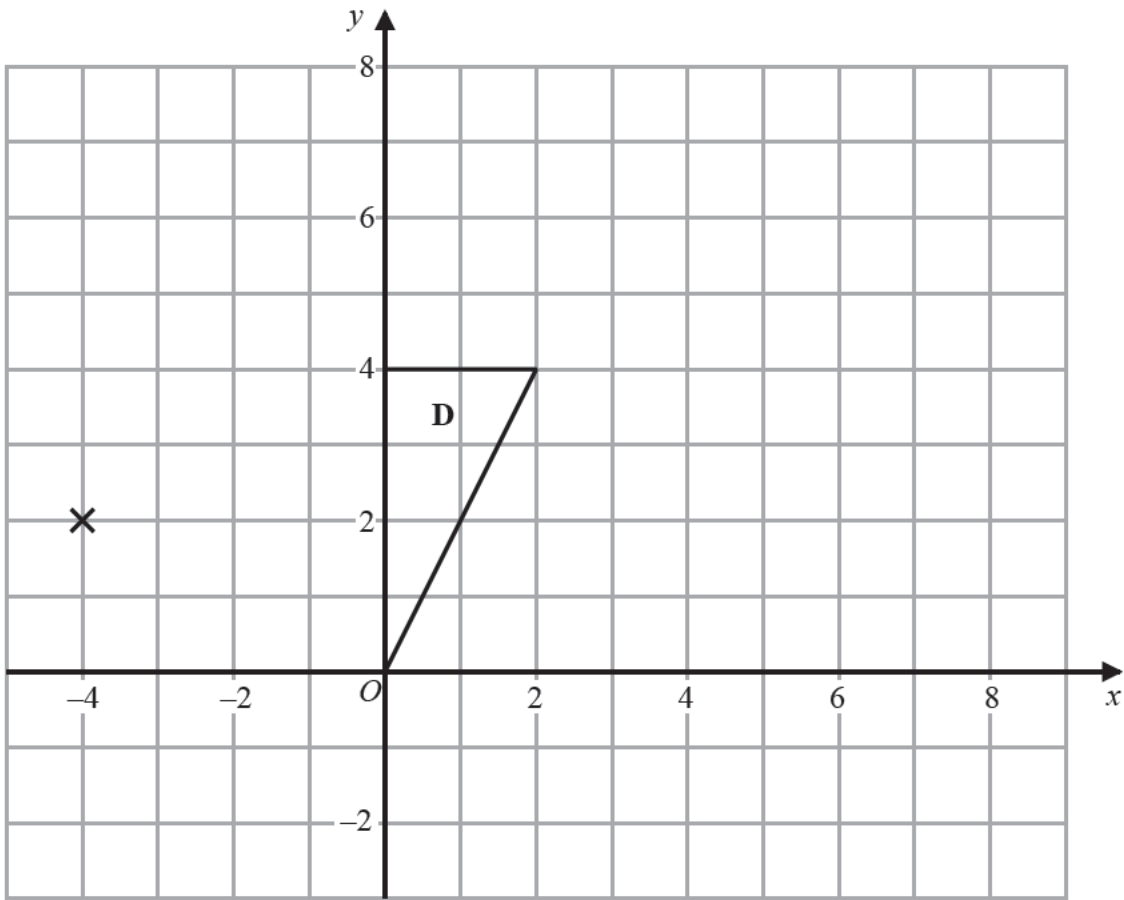

(c) On the grid, enlarge triangle **D** with scale factor $\frac{1}{2}$ and centre $(-4, 2)$

(2)

(Total for Question 2 is 6 marks)



3 Here is a biased 5-sided spinner.

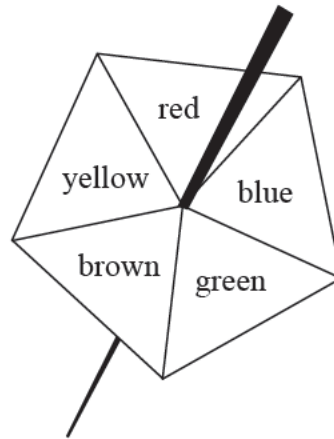

When the spinner is spun, it can land on red, blue, green, brown or yellow.

The table gives the probabilities that the spinner lands on red or on blue or on green.

Colour	red	blue	green	brown	yellow
Probability	0.15	0.26	0.33		

When the spinner is spun once, the probability that the spinner lands on brown is 0.06 more than the probability that the spinner lands on yellow.

Jenine spins the spinner 150 times.

Work out an estimate for the number of times the spinner lands on yellow.

(Total for Question 3 is 4 marks)

DO NOT WRITE IN THIS AREA

DO NOT WRITE IN THIS AREA

DO NOT WRITE IN THIS AREA

DO NOT WRITE IN THIS AREA

DO NOT WRITE IN THIS AREA

DO NOT WRITE IN THIS AREA



4 The table gives information about the price of gold.

	1st February 2016	1st March 2016
Price of one ounce of gold (dollars)	1126.50	1236.50

- (a) Work out the percentage increase in the price of gold between 1st February 2016 and 1st March 2016
Give your answer correct to 3 significant figures.

(3) %

The price of one ounce of gold on 1st February 2016 was 1126.50 dollars.
The price of gold increased by 19% from 1st February 2016 to 1st July 2016

- (b) Work out the price of one ounce of gold on 1st July 2016
Give your answer correct to the nearest dollar.

(3) dollars

(Total for Question 4 is 6 marks)



5

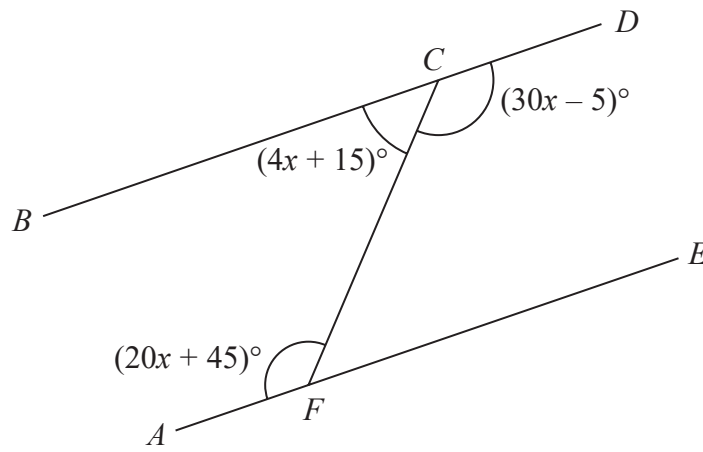

Diagram **NOT** accurately drawn

BCD and AFE are straight lines.

Show that BCD is parallel to AFE .

Give reasons for your working.

DO NOT WRITE IN THIS AREA

DO NOT WRITE IN THIS AREA

DO NOT WRITE IN THIS AREA

DO NOT WRITE IN THIS AREA

DO NOT WRITE IN THIS AREA

DO NOT WRITE IN THIS AREA

(Total for Question 5 is 5 marks)



6 (a) Complete the table of values for $y = x^2 - 5x + 6$

x	0	1	2	3	4	5
y	6		0	0	2	

(1)

(b) On the grid, draw the graph of $y = x^2 - 5x + 6$ for $0 \leq x \leq 5$

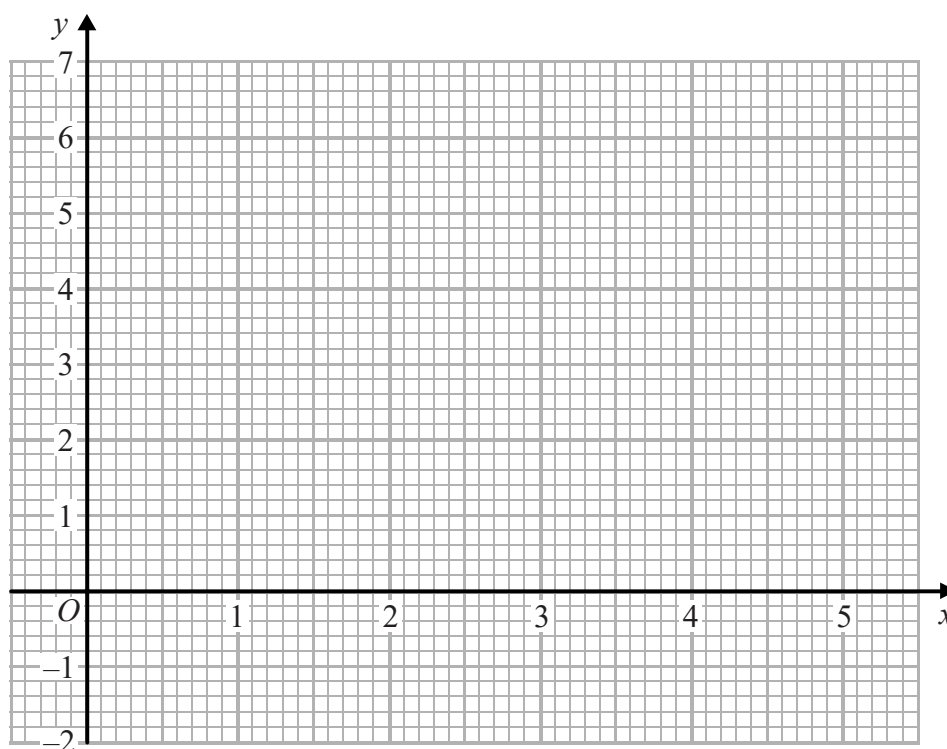

(2)

(c) By drawing a suitable straight line on the grid, find estimates for the solutions of the equation

$$x^2 - 5x = x - 7$$

(3)

(Total for Question 6 is 6 marks)



7 The table shows the volumes, in km^3 , of four oceans.

Ocean	Volume (km^3)
Arctic Ocean	1.88×10^7
Atlantic Ocean	3.10×10^8
Indian Ocean	2.64×10^8
Southern Ocean	7.18×10^7

(a) Write 7.18×10^7 as an ordinary number.

(1)

(b) Calculate the total volume of these four oceans.

(2)

km^3

The volume of the South China Sea is $9\,880\,000\text{ km}^3$

(c) Write $9\,880\,000$ in standard form.

(1)

(Total for Question 7 is 4 marks)

DO NOT WRITE IN THIS AREA

DO NOT WRITE IN THIS AREA

DO NOT WRITE IN THIS AREA

DO NOT WRITE IN THIS AREA

DO NOT WRITE IN THIS AREA

DO NOT WRITE IN THIS AREA



8 The diagram shows an isosceles triangle.

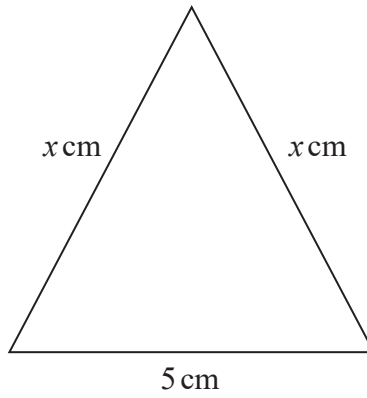

Diagram **NOT** accurately drawn

The area of the triangle is 12 cm^2

Work out the perimeter of the triangle.

Give your answer correct to 3 significant figures.

cm

(Total for Question 8 is 4 marks)



9 The table shows information about the speeds of 60 cycles.

Speed (s km/h)	Frequency
$0 < s \leq 10$	3
$10 < s \leq 20$	16
$20 < s \leq 30$	24
$30 < s \leq 40$	10
$40 < s \leq 50$	5
$50 < s \leq 60$	2

(a) Complete the cumulative frequency table.

Speed (s km/h)	Cumulative frequency
$0 < s \leq 10$	
$0 < s \leq 20$	
$0 < s \leq 30$	
$0 < s \leq 40$	
$0 < s \leq 50$	
$0 < s \leq 60$	

(1)

DO NOT WRITE IN THIS AREA

DO NOT WRITE IN THIS AREA

DO NOT WRITE IN THIS AREA

DO NOT WRITE IN THIS AREA

DO NOT WRITE IN THIS AREA

DO NOT WRITE IN THIS AREA



(b) On the grid, draw a cumulative frequency graph for your table.

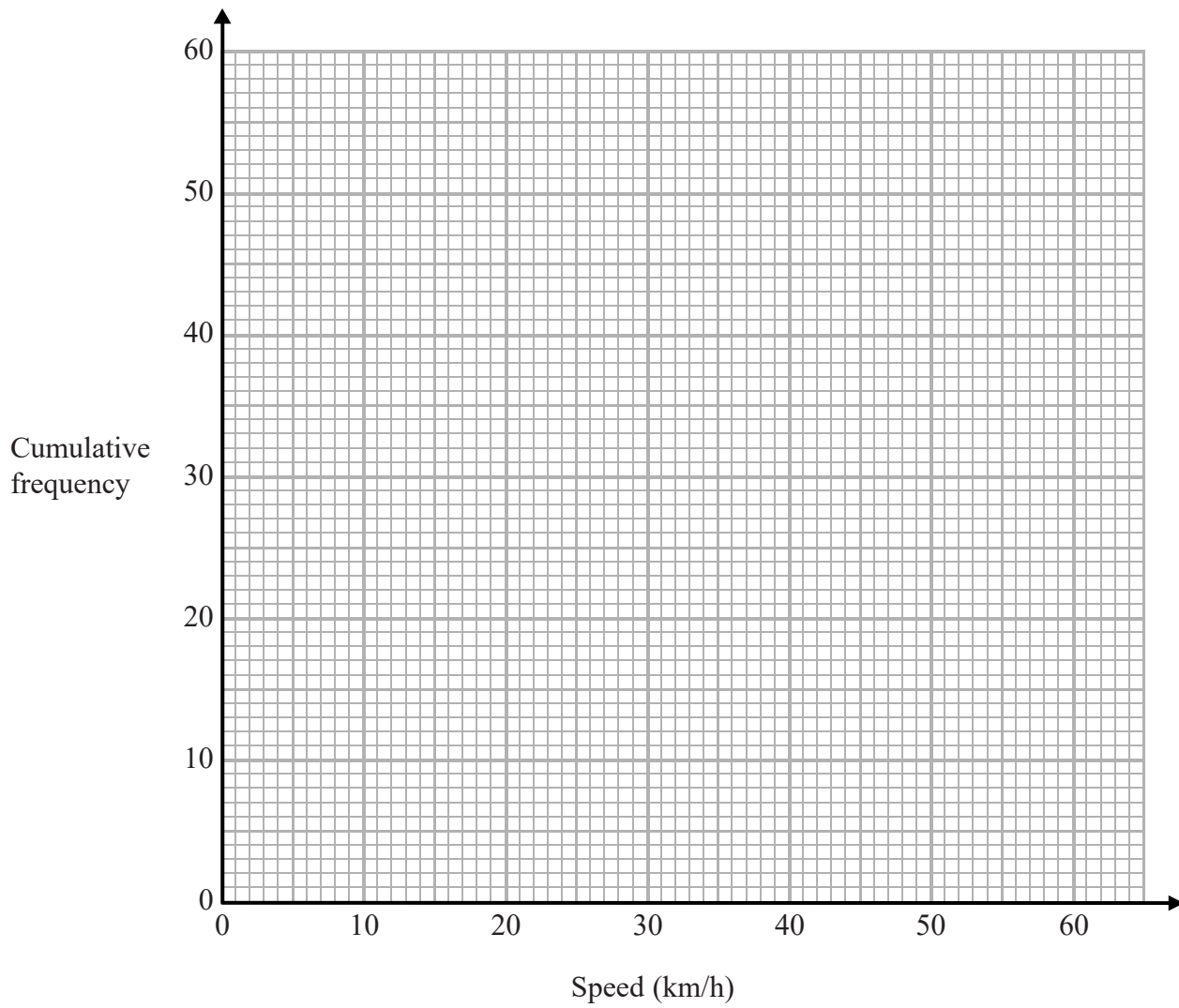

(2)

(c) Use your graph to find an estimate for the interquartile range of the speeds.

km/h

(2)

(Total for Question 9 is 5 marks)



10 Here is triangle ABD .

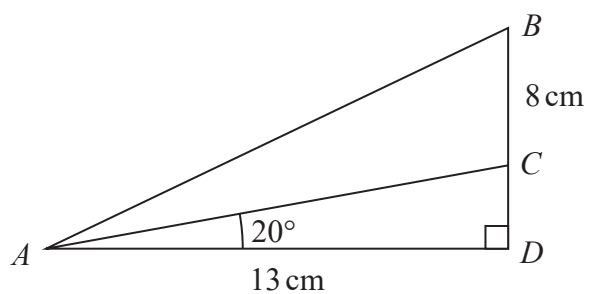

Diagram **NOT** accurately drawn

The point C lies on BD .

$AD = 13\text{ cm}$ $BC = 8\text{ cm}$ angle $ADB = 90^\circ$ angle $CAD = 20^\circ$

Calculate the size of angle BAC .

Give your answer correct to 1 decimal place.

DO NOT WRITE IN THIS AREA

DO NOT WRITE IN THIS AREA

DO NOT WRITE IN THIS AREA

DO NOT WRITE IN THIS AREA

DO NOT WRITE IN THIS AREA

DO NOT WRITE IN THIS AREA

(Total for Question 10 is 5 marks)



11 Express $\frac{5}{3} - \frac{x+2}{2x}$ as a single fraction in its simplest terms.

(Total for Question 11 is 3 marks)



12 The curve C has equation $y = \frac{1}{3}x^3 - 9x + 1$

(a) Find $\frac{dy}{dx}$

$$\frac{dy}{dx} = \quad (2)$$

(b) Find the range of values of x for which C has a negative gradient.

(3)

(Total for Question 12 is 5 marks)

DO NOT WRITE IN THIS AREA

DO NOT WRITE IN THIS AREA

DO NOT WRITE IN THIS AREA

DO NOT WRITE IN THIS AREA

DO NOT WRITE IN THIS AREA

DO NOT WRITE IN THIS AREA



13 All the students in Year 11 at a school must study at least one of Geography (G), History (H) and Religious Studies (R).

In Year 11 there are 65 students.

Of these students

- 15 study Geography, History and Religious Studies
- 21 study Geography and History
- 16 study Geography and Religious Studies
- 30 study Geography
- 18 study only Religious Studies
- 37 study Religious Studies

(a) Using this information, complete the Venn diagram to show the number of students in each region of the Venn diagram.

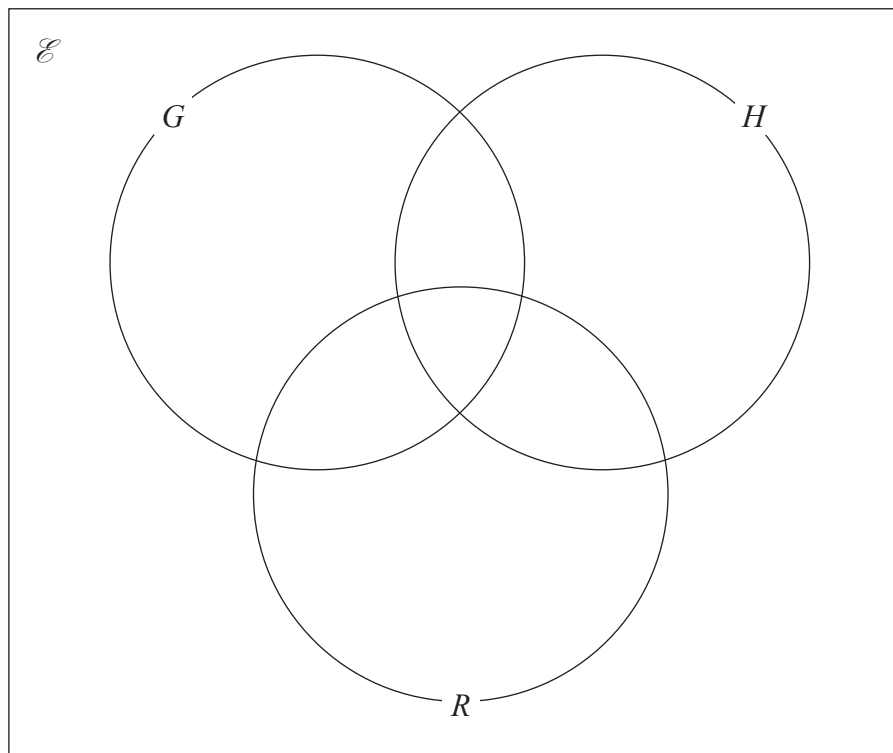

(3)

A student in Year 11 who studies both History and Religious Studies is chosen at random.

(b) Work out the probability that this student does **not** study Geography.

(2)

(Total for Question 13 is 5 marks)



14 T is directly proportional to the cube of r

$$T = 21.76 \text{ when } r = 4$$

(a) Find a formula for T in terms of r

(3)

(b) Work out the value of T when $r = 6$

(1)

(Total for Question 14 is 4 marks)

DO NOT WRITE IN THIS AREA

DO NOT WRITE IN THIS AREA

DO NOT WRITE IN THIS AREA

DO NOT WRITE IN THIS AREA

DO NOT WRITE IN THIS AREA

DO NOT WRITE IN THIS AREA



15 The total surface area of a solid hemisphere is equal to the curved surface area of a cylinder.

The radius of the hemisphere is r cm.

The radius of the cylinder is twice the radius of the hemisphere.

Given that

$$\text{volume of hemisphere} : \text{volume of cylinder} = 1 : m$$

find the value of m .

$$m =$$

(Total for Question 15 is 4 marks)



16 (a) Rationalise the denominator of $\frac{a + \sqrt{4b}}{a - \sqrt{4b}}$ where a is an integer and b is a prime number.

Simplify your answer.

(b) Given that $\left(\sqrt{\frac{y}{x}}\right)^{-5} = \frac{x^m}{y^m}$ where $x \neq y$

find the value of m .

$$m =$$

(3)

(1)

(Total for Question 16 is 4 marks)

DO NOT WRITE IN THIS AREA

DO NOT WRITE IN THIS AREA

DO NOT WRITE IN THIS AREA

DO NOT WRITE IN THIS AREA

DO NOT WRITE IN THIS AREA

DO NOT WRITE IN THIS AREA



17 Here is triangle ABC .

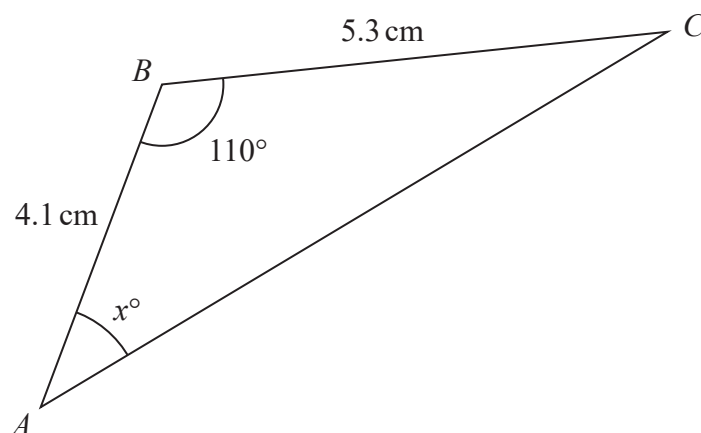

Diagram **NOT** accurately drawn

Calculate the value of x .
Give your answer correct to 3 significant figures.

(Total for Question 17 is 5 marks)



18 The graph of $y = f(x)$ is shown on the grid.

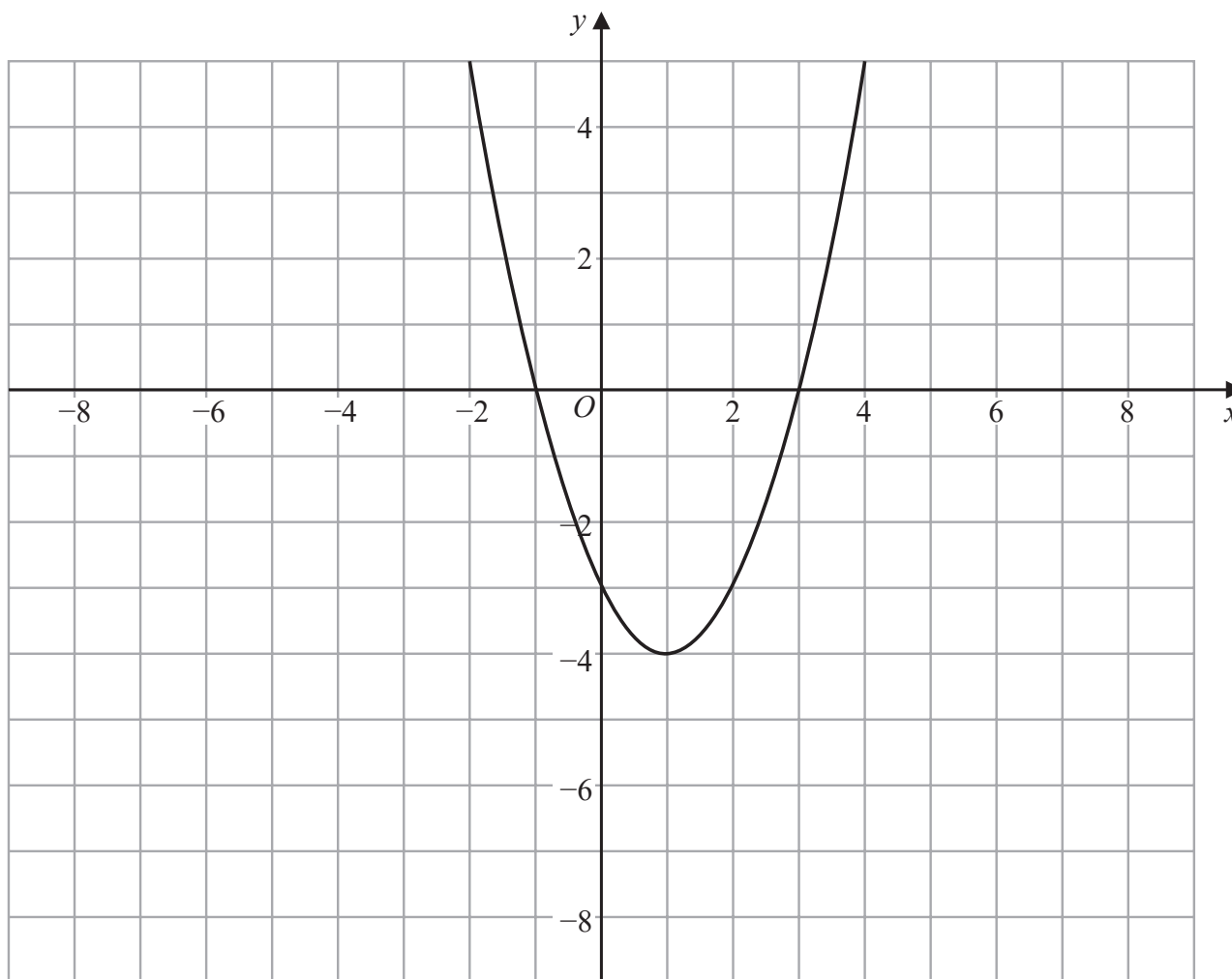

(a) On the grid above, sketch the graph of $y = f\left(\frac{1}{2}x\right)$

(2)

DO NOT WRITE IN THIS AREA

DO NOT WRITE IN THIS AREA

DO NOT WRITE IN THIS AREA

DO NOT WRITE IN THIS AREA

DO NOT WRITE IN THIS AREA

DO NOT WRITE IN THIS AREA



The graph of $y = f(x + k)$ is shown on the grid below.

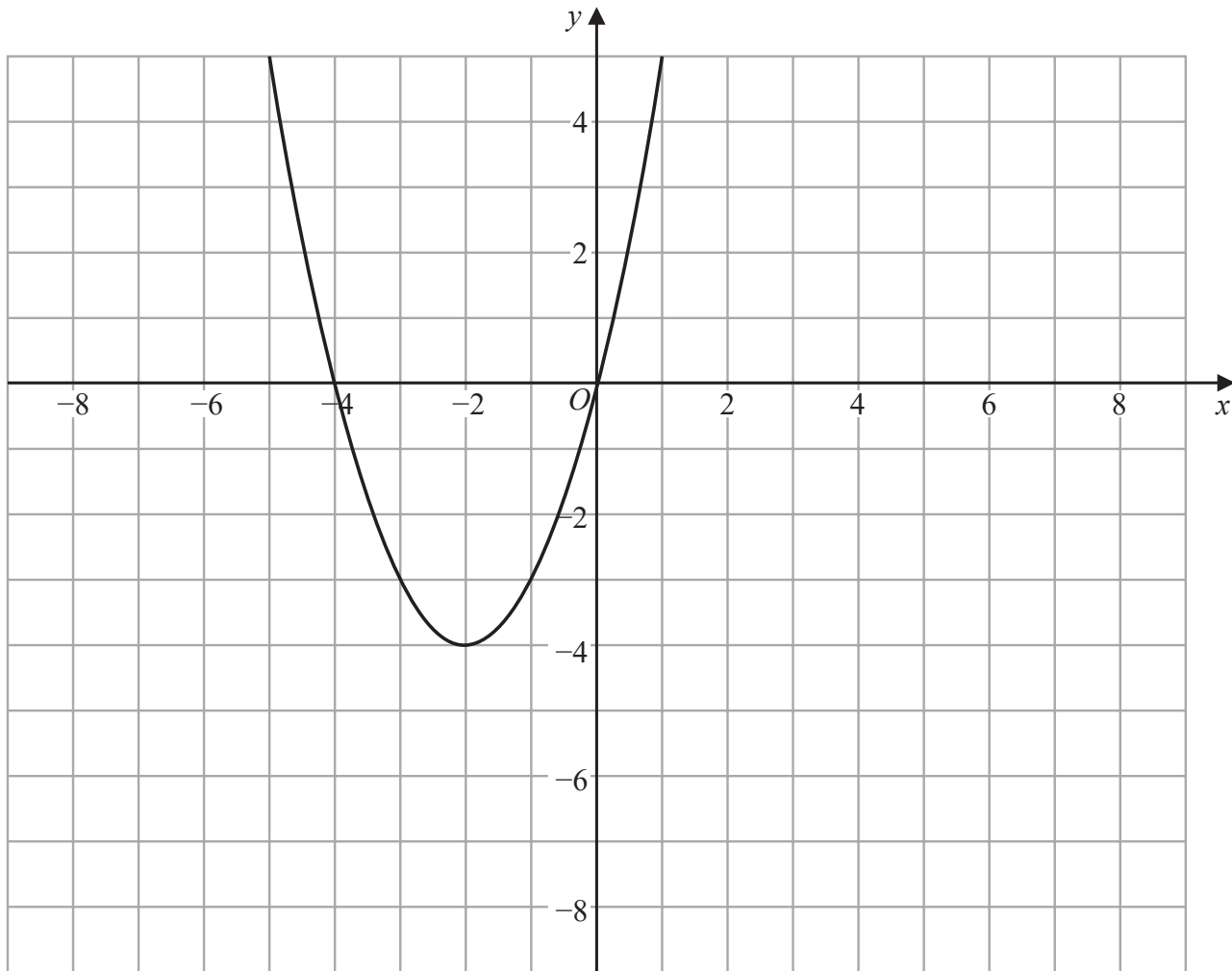

(b) Write down the value of k

(1)

(Total for Question 18 is 3 marks)



19 g is the function with domain $x \geq -3$ such that $g(x) = x^2 + 6x$

(a) Write down the range of g^{-1}

(1)

(b) Express the inverse function g^{-1} in the form $g^{-1}:x \mapsto \dots$

$g^{-1}:x \mapsto$

(4)

(Total for Question 19 is 5 marks)

DO NOT WRITE IN THIS AREA

DO NOT WRITE IN THIS AREA

DO NOT WRITE IN THIS AREA

DO NOT WRITE IN THIS AREA

DO NOT WRITE IN THIS AREA

DO NOT WRITE IN THIS AREA



- 20 A bowl contains n pieces of fruit.
Of these, 4 are oranges and the rest are apples.

Two pieces of fruit are going to be taken at random from the bowl.

The probability that the bowl will then contain $(n - 6)$ apples is $\frac{1}{3}$

Work out the value of n
Show your working clearly.

(Total for Question 20 is 6 marks)



21 $(2x + 23)$, $(8x + 2)$ and $(20x - 52)$ are three consecutive terms of an arithmetic sequence.

Prove that the common difference of the sequence is 12

DO NOT WRITE IN THIS AREA

DO NOT WRITE IN THIS AREA

DO NOT WRITE IN THIS AREA

DO NOT WRITE IN THIS AREA

DO NOT WRITE IN THIS AREA

DO NOT WRITE IN THIS AREA

(Total for Question 21 is 4 marks)

TOTAL FOR PAPER IS 100 MARKS



DO NOT WRITE IN THIS AREA

DO NOT WRITE IN THIS AREA

DO NOT WRITE IN THIS AREA

DO NOT WRITE IN THIS AREA

DO NOT WRITE IN THIS AREA

DO NOT WRITE IN THIS AREA

BLANK PAGE



DO NOT WRITE IN THIS AREA

DO NOT WRITE IN THIS AREA

DO NOT WRITE IN THIS AREA

BLANK PAGE

