

Examiners' Report June 2015

IAL Physics WPH04 01

Edexcel and BTEC Qualifications

Edexcel and BTEC qualifications come from Pearson, the UK's largest awarding body. We provide a wide range of qualifications including academic, vocational, occupational and specific programmes for employers. For further information visit our qualifications websites at www.edexcel.com or www.btec.co.uk.

Alternatively, you can get in touch with us using the details on our contact us page at www.edexcel.com/contactus.

ResultsPlus

Giving you insight to inform next steps

ResultsPlus is Pearson's free online service giving instant and detailed analysis of your students' exam results.

- See students' scores for every exam question.
- Understand how your students' performance compares with class and national averages.
- Identify potential topics, skills and types of question where students may need to develop their learning further.

For more information on ResultsPlus, or to log in, visit www.edexcel.com/resultsplus. Your exams officer will be able to set up your ResultsPlus account in minutes via Edexcel Online.

Pearson: helping people progress, everywhere

Pearson aspires to be the world's leading learning company. Our aim is to help everyone progress in their lives through education. We believe in every kind of learning, for all kinds of people, wherever they are in the world. We've been involved in education for over 150 years, and by working across 70 countries, in 100 languages, we have built an international reputation for our commitment to high standards and raising achievement through innovation in education. Find out more about how we can help you and your students at: www.pearson.com/uk.

June 2015

Publications Code IA042393

All the material in this publication is copyright
© Pearson Education Ltd 2015

Introduction

This paper was generally well answered with candidates able to attempt all question parts and demonstrate an understanding of the physics that was being tested. All of the question parts were accessible to the majority of candidates and all of the marks were awarded to some candidates. There were a number of question parts that were more challenging and these provided good discrimination across the paper.

Candidates generally performed better on calculations and short answers and not so well on longer descriptive questions.

Multiple Choice Questions

Question	Topic	% correct	Common wrong answer
1	Nuclear structure	97	
2	Momentum equations	65	B
3	Speed of particle in accelerators	68	A
4	Radius of path in magnetic field	74	C
5	Capacitors with same energy	49	A
6	Fleming's LH rule	65	A
7	Particle interaction	69	B
8	Variation of induced e.m.f.	82	A
9	Particle tracks in detector	79	A/C
10	Energy of a particle decay	58	A

Q2. Candidates chose the answers that had s^{-1} in the unit, presumably because that implies a rate.

Q3. The clue was the mass quoted was much more than the mass of electron given in the data, hence it must be travelling close to the speed of light.

Q4. This was a direct application of a given formula $r = p/BQ$. Answer C was chosen because it was the only decrease, and candidates ignored the inverse relationship.

Q8. By choosing B candidates realised that the induced e.m.f. was increasing, but they ignored the fact that there was a non-zero gradient at 0 so that at time = 0, there was a value of e.m.f.

Q9. Perhaps because there was no track for the lambda particle, candidates assumed that it was stationary despite the fact that there is clearly momentum after the decay.

Q10. In a particle interaction mass and kinetic energy are interchangeable so the reference to total energy meant rest energy (mass) and kinetic energy, meaning that the conservation of energy gives B as the correct answer.

Question 11 (a)

This question required candidates to explain what is meant by an inverse square law and 40% of candidates did not score any marks. Other candidates who could explain what it meant and so scored one mark, did not make any reference to the graph.

- 11 An alpha particle ${}^4_2\text{He}$ is travelling directly towards the nucleus of a gold atom ${}^{197}_{79}\text{Au}$. The graph shows how the force F between the particles varies with their separation r over a short distance.

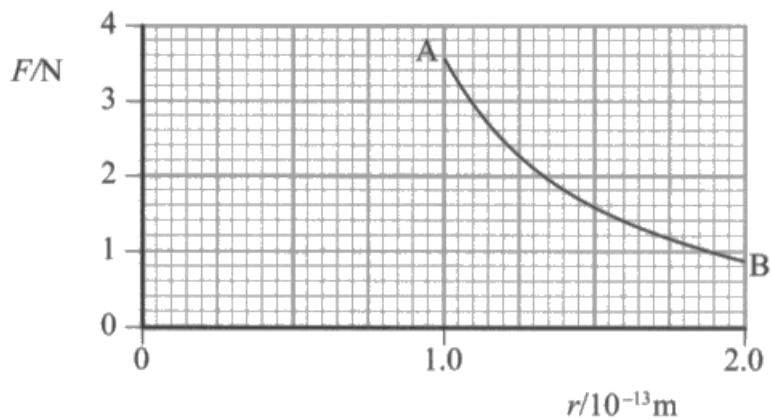

- (a) The relationship between F and r obeys an inverse square law. With reference to points A and B on the graph, explain what this means.

(2)

$$F \propto \frac{1}{r^2} \quad F = \frac{k}{r^2} \quad 3.6 = \frac{k}{(10^{-13})^2} \quad k = 3.6 \times 10^{-26}$$

$$0.9 = \frac{3.6 \times 10^{-26}}{(2 \times 10^{-13})^2}$$

$$0.9 = 0.9 //$$



ResultsPlus Examiner Comments

This is an example of an answer that scores both marks. It states the relationship, finds a value for k , and then uses that with the other pair of readings to justify the value of 9 N.



ResultsPlus Examiner Tip

When the question says 'with reference to points A and B', you are expected to use those values from the graph.

- 11 An alpha particle ${}^4_2\text{He}$ is travelling directly towards the nucleus of a gold atom ${}^{197}_{79}\text{Au}$. The graph shows how the force F between the particles varies with their separation r over a short distance.

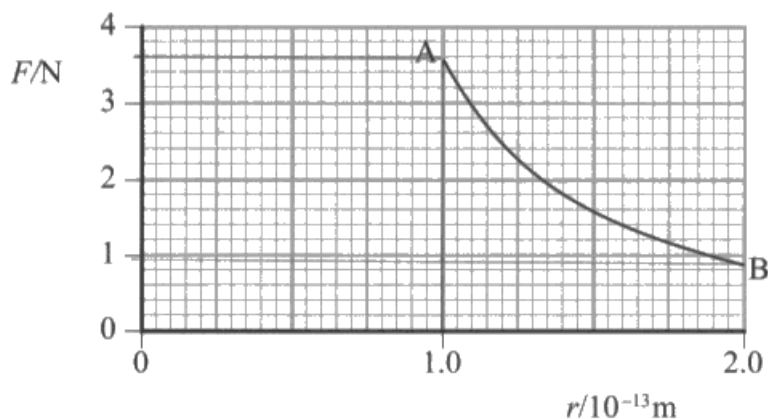

- (a) The relationship between F and r obeys an inverse square law. With reference to points A and B on the graph, explain what this means.

(2)

at Point A, $F = 3.6 \text{ N}$ at Point B, $F = 0.9 \text{ N}$
 $r = 1.0 \times 10^{-13} \text{ m}$ $r = 2.0 \times 10^{-13} \text{ m}$
 When F increases, r decreases.



ResultsPlus
Examiner Comments

This candidate has just written down the values at A and B and hasn't used them so this gets no credit. Also the statement that F increases, r decreases is not enough since that occurs for relationships other than the inverse square law.



ResultsPlus
Examiner Tip

The values from the graph need to be used and not just written down.

Question 11 (b)

Nearly half of the candidates scored the full three marks but the next most common mark was zero. There were two different methods, either a calculation using Coulomb's law and substituting values of charges and distance or using the constant found in (a). For the first method, the most common mistake was centred around the use of 2 and 79 with the electronic charge. Using the value of the constant from (a) was possibly more straightforward, but success was dependent on candidates getting the powers of ten correct. Powers of ten could be ignored in (a) when deriving two values of the constant but needed to be correct for this section.

(b) Calculate the force between the alpha particle and the gold nucleus when their separation is at its minimum value of 4.5×10^{-14} m.

(3)

$$F = k \frac{Q_1 Q_2}{r^2} = (8.99 \times 10^9) \frac{(2 \times 1.6 \times 10^{-19})(79 \times 1.6 \times 10^{-19})}{(4.5 \times 10^{-14})^2} = 18.0 \text{ N}$$



ResultsPlus

Examiner Comments

A model answer using Coulomb's law with the correct charges.

(b) Calculate the force between the alpha particle and the gold nucleus when their separation is at its minimum value of 4.5×10^{-14} m.

(3)

$$F = k \frac{Q_1 Q_2}{r^2} \quad k = \frac{1}{4} \pi \epsilon_0 \quad \epsilon_0 = 8.85 \times 10^{-12} \text{ F m}^{-1}$$

$$F = \frac{\frac{1}{4} \pi (8.85 \times 10^{-12}) (2) (+79)}{(4.5 \times 10^{-14})^2} = \frac{2440.49 \text{ N}}{\cancel{2440.49 \text{ N}}} = \cancel{2440.49 \text{ N}} = 2440 \text{ N}$$

$$\text{Force} = 2440 \text{ N}$$



ResultsPlus

Examiner Comments

This answer demonstrates the confusion that can occur with this equation. The candidate has put the $\pi \epsilon_0 / 4$ on the top of the equation and has omitted the value for e twice. This scored zero marks.

(b) Calculate the force between the alpha particle and the gold nucleus when their separation is at its minimum value of 4.5×10^{-14} m.

(3)

$$F = \frac{3.6 \times 10^{-26}}{(4.5 \times 10^{-14})^2} = 17.78 \text{ N}$$

$$F = \frac{k}{r^2}$$



ResultsPlus
Examiner Comments

A 3 mark answer using the constant from (a)

Question 12 (a)

A calculation which candidates scored well on, providing they used a correct equation and remembered to add a unit.

(a) Initially the switch makes contact at X.

Calculate the charge stored by the capacitor when it is fully charged.

(2)

$$C = Q/V = \frac{0.680 \times 10^{-6}}{1.5} = 0.0102 \text{ C}$$



ResultsPlus Examiner Comments

Candidates still get confused between C being used for the quantity capacitance and the unit coulomb. This candidate thinks the C is for charge and divides the two pieces of data, scoring zero.



ResultsPlus Examiner Tip

Remember that C is used for capacitance and coulombs. Q is used for charge.

(a) Initially the switch makes contact at X.

Calculate the charge stored by the capacitor when it is fully charged.

(2)

$$C = Q/V$$

$$0.68 = Q/1.5$$

$$Q = 1.02 \text{ C}$$

$$\text{Charge} = 1.02 \text{ C}$$



ResultsPlus Examiner Comments

This candidate has confused nano and milli. This scores 1 mark for use of equation.

Question 12 (b)

The calculation was generally well answered with many candidates able to handle the exponential equation. Weaker candidates could substitute into the equation and do the unit conversion but struggled to manipulate the equation to get an answer. Others having found the correct value of charge then subtracted it from the original, thereby finding the amount of charge lost rather than the amount remaining. This lost the candidates the answer mark. The most commonly lost mark was the last one for the comment because answers were often too general, such as decay is exponential or charge is below 37% of initial charge. Since the starting amount of charge was μC answers that stated amount of charge was small were not given credit.

Question 12 (c)

Candidates struggled with this and did not realise that multiplying a charge by the number of times it is charged per second gives you a current. Many divided by 500 and despite the question clearly stating that it is charged and discharged 500 times per second chose to multiply/divide by 250. Many candidates thought that they needed to use $V=IR$, presumably because they did not know how to tackle this question and were randomly using an equation that contained a current.

(c) The capacitor is charged and discharged 500 times per second.

Calculate the average current through the ammeter.

(2)

$$R = V/I$$

$$220 = \frac{1.5}{I}$$

$$I = \frac{1.5}{220} = 6.8 \times 10^{-3} \text{ A}$$

$$500 \times 6.8 \times 10^{-3} = 3.4 \text{ A}$$

Average current = 3.4 A



ResultsPlus
Examiner Comments

The candidate uses the circuit values to find a current and then multiplies by 500, so gains no marks.

(c) The capacitor is charged and discharged 500 times per second.

Calculate the average current through the ammeter.

(2)

$$F = 500 \text{ Hz} \quad T = \frac{1}{500} = 2 \times 10^{-3} \text{ s}$$

$$Q = It$$

$$I = \frac{Q}{t} = \frac{1.02 \times 10^{-6}}{2 \times 10^{-3}} = 5.1 \times 10^{-4} \text{ A} = 510 \mu\text{A}$$

$$\text{Average current} = 510 \mu\text{A}$$



ResultsPlus
Examiner Comments

This candidate finds the time for one discharge and uses this to find the current. This is correct and scores both marks but making it a two step calculation increases the risk of error.

Question 13 (a)

Candidates performed well here, remembering to add the reference to external forces. However, marks were lost due to omission of total or sum. Only 40% of candidates scored the 2 marks for a definition.

13 (a) State the principle of conservation of momentum.

(2)

The total momentum before a collision is equal to the total momentum after collision



ResultsPlus
Examiner Comments

Scores 1 mark but no mention of external forces.



ResultsPlus
Examiner Tip

Basic definitions are necessary for learning.

13 (a) State the principle of conservation of momentum.

(2)

$p = MV$ ~~$p_1 + p_2 = p_3 + p_4$~~ mass-velocity constant conserved, given that no external forces are involved



ResultsPlus
Examiner Comments

If symbols are used for definitions they must be defined. This scores 1 mark for the reference to no external forces.



ResultsPlus
Examiner Tip

It is best to always use words for definitions or principles.

Question 13 (b) (i)

This was generally well done, with the majority of candidates scoring all 4 marks. The most common error was to fail to subtract the two initial momenta. If they had not identified a positive direction, they could not score the last marking point for identifying the direction of motion after the collision. The other mistake was to not add the arrow to the diagram.

- (b) A head-on collision occurs between a neutron and a beryllium atom ${}^9_4\text{Be}$. The nucleus of the beryllium atom absorbs the neutron to form the isotope ${}^{10}_4\text{Be}$.

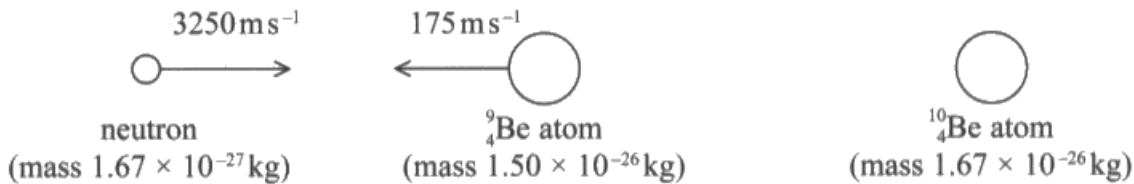

- (i) Calculate the velocity of the ${}^{10}_4\text{Be}$ atom, indicating its direction by adding an arrow to the diagram.

(4)

~~mass~~ ~~to~~ Total momentum before = total momentum after

$$\left((1.67 \times 10^{-27}) \times 3250 \right) - \left((1.5 \times 10^{-26}) \times 175 \right) = (1.67 \times 10^{-26}) v$$

$$2.8025 \times 10^{-24} = 1.67 \times 10^{-26} v$$

$v = 167.8 \text{ ms}^{-1}$ ~~to the left~~ ~~towards the~~
 In the same direction of the neutron before the collision

Velocity = 167.8 ms^{-1}



ResultsPlus
 Examiner Comments

Correct calculation of speed for 3 marks, but arrow not added to diagram.

(b) A head-on collision occurs between a neutron and a beryllium atom ${}^9_4\text{Be}$. The nucleus of the beryllium atom absorbs the neutron to form the isotope ${}^{10}_4\text{Be}$.

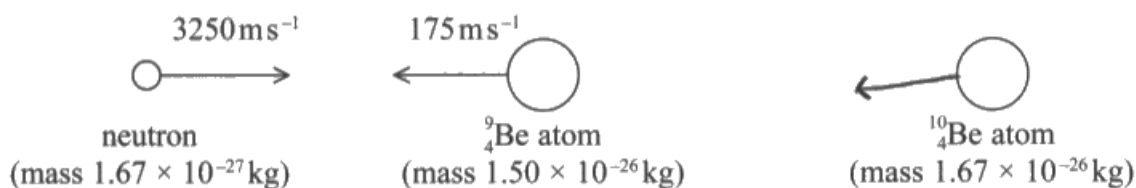

(i) Calculate the velocity of the ${}^{10}_4\text{Be}$ atom, indicating its direction by adding an arrow to the diagram.

(4)

$$m_1 u_1 + m_2 u_2 = m_1 v_1 + m_2 v_2$$

$$(1.67 \times 10^{-27})(3250) + (1.50 \times 10^{-26})(175) = 1.67 \times 10^{-26} v$$

$$5.4275 \times 10^{-24} + 2.625 \times 10^{-24} = 1.67 \times 10^{-26} v$$

$$8.0525 \times 10^{-24} = 1.67 \times 10^{-26} v$$

$$v = 482.19 \text{ ms}^{-2}$$

$$\text{Velocity} = 482.19 \text{ ms}^{-2}$$



ResultsPlus

Examiner Comments

The common wrong answer where the initial momenta are added. This scored 1 mark for the use of momentum = mass x velocity.

Question 13 (b) (ii)

The majority of candidates were able to find the total kinetic energy before and after the collision and identified that the collision was inelastic. Error carried forward was allowed from (b)(i) so candidates who added the momenta in (i) were able to score both marks in this section.

- (ii) Using a suitable calculation, determine whether the collision was elastic or inelastic.

(2)

$$\text{Total k.E before Collision} = \frac{1}{2} \times (1.67 \times 10^{-27}) \times (3250)^2$$

$$+ \frac{1}{2} \times (1.50 \times 10^{-26}) \times (175)^2 = 9.05 \times 10^{-21} \text{ J}$$

$$\text{Total k.E after Collision} = \frac{1}{2} \times (1.67 \times 10^{-26}) \times (1688)^2$$
$$= 2.38 \times 10^{-22} \text{ J} \quad \text{inelastic Collision}$$

Total k.E before \neq Total k.E after \therefore Inelastic

\therefore Inelastic Collision

(Total for Question 13 = 8 marks)



ResultsPlus
Examiner Comments

Correct answer for 2 marks.

- (ii) Using a suitable calculation, determine whether the collision was elastic or inelastic.

(2)

$$\frac{1}{2}mv^2$$

$$\frac{1}{2} \times 1.67 \times 10^{-27} \times 3250^2 + \frac{1}{2} \times 1.5 \times 10^{-26} \times 175^2 = \frac{1}{2} \times 1.67 \times 10^{-26} \times 1688^2$$

$$9.049375 \times 10^{-21} \neq 1.40125 \times 10^{-24}$$

KE not conserved so inelastic collision.



ResultsPlus
Examiner Comments

The calculations are set up correctly but the value for final kinetic energy is wrong and so this scores 1 mark.



ResultsPlus
Examiner Tip

Double check calculations to avoid calculator errors.

- (ii) Using a suitable calculation, determine whether the collision was elastic or inelastic.

(2)

$$P \text{ before collision} = \frac{1}{2} \times (1.67 \times 10^{-26})^2$$

$$\frac{1}{2} \times 1.67 \times 10^{-27} \times 250 - \frac{1}{2} \times 1.50 \times 10^{-26} \times 175 = \underline{1.40 \times 10^{-24} \text{ J}}$$

$$P \text{ After collision} = \frac{1}{2} \times 1.67 \times 10^{-26} \times 167 + \frac{1}{2} \times 1.50 \times 10^{-26} \times 250 = \underline{1.40 \times 10^{-24} \text{ J}}$$

\therefore the energies are equal it is an elastic collision.

(Total for Question 13 = 8 marks)



ResultsPlus

Examiner Comments

This example calculates $mv/2$, neither momentum or kinetic energy and treats it as a vector quantity, so not surprisingly ends up with the same values. This scored 0.

Question 14 (a)

50% of the candidates scored 2 marks with another 26% scoring one mark and 24% scoring 0. The reasons why candidates did not score both marks were as follows: stating 'produced' rather than 'induced', voltage or current instead of e.m.f, no indication of rate or time, writing the equation without defining symbols, and vague answers relating to conductor movement and magnetic fields.

14 (a) State Faraday's law of electromagnetic induction.

(2)

The induced emf is directly proportional
to the rate at which magnetic ~~field~~ field
lines are cut.

$$\varepsilon = \frac{N \Delta \Phi}{\Delta t}$$



ResultsPlus

Examiner Comments

This scored 1 mark for the induced e.m.f. The rate at which field lines are cut is not the same as the rate of change of flux linkage.

14 (a) State Faraday's law of electromagnetic induction.

(2)

emf is directly ~~prod~~ proportional to the rate of
change of flux linkage

$$\varepsilon = - \frac{d(N\Phi)}{dt}$$



ResultsPlus

Examiner Comments

No 'induced' so scores 1 mark. Again no credit for the equation as terms have not been defined.



ResultsPlus

Examiner Tip

The induced e.m.f. is proportional to the rate of change of magnetic flux linkage. Learn this definition.

Question 14 (b) (i)

Candidates whose first language is not English often struggle with the descriptive context questions and this was seen in this question, where very few candidates scored the full 3 marks. Asking candidates to state Faraday's law gave them an indication about the physics of this question and most candidates were able to score 1 or 2 marks. Very few candidates identified that the cables under the road produced a changing magnetic field. Candidates were expected to link the induced e.m.f. to the charging of the batteries. Possibly because of language issues and the use of the word 'charging' relating to batteries, many candidates thought that capacitors were involved. This wasn't too apparent in (b)(i) and in itself did not stop marks being awarded but it became more of an issue in (b)(ii).

- (b) Vehicles such as buses may be powered by electric motors. The motors on these buses use batteries which need to be charged often. This is normally done by connecting to a fixed electrical supply whilst the bus is parked.

The photograph shows a bus on a road in South Korea. This road enables the batteries to charge whilst the bus is in motion.



Under the road there are electric cables, connected to a 440V 60 Hz supply. These generate magnetic fields. There is a coil inside the charging device which is located below the floor of the bus. This enables the batteries on the bus to charge.

- * (i) Explain how this system works.

(3)

There ~~is~~ ^{are} magnetic fields under the roads which produces magnetic flux. There ~~is~~ ^{change in} a ~~constant~~ amount of magnetic flux, ~~but~~ ^{due to a.c. supply and} the bus is ^{under} motion ~~where~~ which in turn coil is ^{under} motion. ∴ there is a change in flux in linked at the coil in the bus and according to Faraday's law rate of change of magnetic flux induces e.m.f which charges battery.



ResultsPlus
Examiner Comments

This is an example that does score 3 marks but less than 10% of the candidates scored full marks.

- (b) Vehicles such as buses may be powered by electric motors. The motors on these buses use batteries which need to be charged often. This is normally done by connecting to a fixed electrical supply whilst the bus is parked.

The photograph shows a bus on a road in South Korea. This road enables the batteries to charge whilst the bus is in motion.



Under the road there are electric cables, connected to a 440V 60 Hz supply. These generate magnetic fields. There is a coil inside the charging device which is located below the floor of the bus. This enables the batteries on the bus to charge.

- *(i) Explain how this system works.

(3)

The power supply is an A-C power supply. Alternating current is supplied which produces a magnetic field. Direction of current changes, direction of magnetic field changes. There is change in magnetic flux linkage ^{through coil}, ~~so~~ a current is induced across the coil, battery begins to charge.



ResultsPlus
Examiner Comments

This scored 2 marks. MP1 is spread over first 5 lines. Reference to AC supply is there but the changing magnetic field is not until line 4 & 5. MP2 lines 5 & 6. Not MP3 because it is an induced current not emf.

(b) Vehicles such as buses may be powered by electric motors. The motors on these buses use batteries which need to be charged often. This is normally done by connecting to a fixed electrical supply whilst the bus is parked.

The photograph shows a bus on a road in South Korea. This road enables the batteries to charge whilst the bus is in motion.



Under the road there are electric cables, connected to a 440V 60 Hz supply. These generate magnetic fields. There is a coil inside the charging device which is located below the floor of the bus. This enables the batteries on the bus to charge.

*(i) Explain how this system works.

(3)

Thanks to the magnetic fields (generated by the electric cables underground) an emf is induced in the coil inside the charging device of the bus. Once the coil carries an emf the batteries can be charged up.



ResultsPlus
Examiner Comments

This scored just MP3. If the candidate had added 'changing' to their first sentence it would have got MP1.

Question 14 (b)(ii)

This was very poorly answered (59% scored zero) with candidates having little appreciation that a battery once charged could drive the bus for a distance before needing recharging. Hardly any candidates indicated that the battery would be repeatedly recharged. A common answer was that the magnetic fields could spread and cover the areas where there were no cables. Many candidates thought that capacitors were involved and referred to these being charged. Some candidates just referred to the factors in Faraday's law that would determine the magnitude of the induced e.m.f.

- (ii) It is not necessary for the cable to be installed under the entire length of the road. The batteries used to power these buses can be much smaller than those used in other electric buses.

Explain why the cables do not need to be installed under the entire length of the road and why the batteries can be smaller.

(3)

~~Because the amount of charge does not~~
~~depend on the current generate, but the frequency~~
~~may also affect affect the emf induced and.~~
Because there would be two factors affecting
the current generate, the change in flux ~~den~~ linkage
and the frequency. The current induced does not
only depend on the amount of coils, it is the
change in magnetic flux linkage which have a
greater effect on the current. **Total for Question 14 = 8 marks)**
and therefore the charge.



ResultsPlus
Examiner Comments

An answer in terms of the factors that affect the induced e.m.f. which scored zero.

- (ii) It is not necessary for the cable to be installed under the entire length of the road. The batteries used to power these buses can be much smaller than those used in other electric buses.

Explain why the cables do not need to be installed under the entire length of the road and why the batteries can be smaller.

(3)

The batteries will be charged when the buses move. As the batteries ^{are} ~~be~~ charged then ~~it~~ ~~does~~ they don't need to be charged for ~~a~~ several ~~the~~ ~~minutes~~ minutes or seconds, and ~~the~~ ~~the~~ batteries can support the buses move for a while. Because the road can charge the batteries several times during the length of the road. So the batteries only need big enough to support the road without cables.



ResultsPlus
Examiner Comments

This scored 2 marks for the repeated charging and the idea that the bus could travel for a while after being recharged.

- (ii) It is not necessary for the cable to be installed under the entire length of the road. The batteries used to power these buses can be much smaller than those used in other electric buses.

Explain why the cables do not need to be installed under the entire length of the road and why the batteries can be smaller.

(3)

These batteries charge up quickly.
So the cables should be installed
at some distance to each
other so that the battery should
be discharged before it is charged
up again. The batteries are smaller
because they get charged up and
discharged simultaneously.

(Total for Question 14 = 8 marks)



ResultsPlus
Examiner Comments

Another example of a 2 mark answer. Batteries charging quickly for MP2 and there is the idea of repeated charging by reference to the battery being charged up again. The candidate was not penalised for using simultaneously wrongly.

Question 15 (a)

60% of candidates managed to score 1 mark with 20% scoring both marks. Some candidates lost marks because of the manner in which they expressed their answers. A common answer was 'there was no tension force therefore it stopped moving in a circle'. The stem of the question asked why the sphere stopped moving in a circle so there is never any credit for just repeating the stem. The second mark was awarded for either stating that a force was needed to change direction or for an indication of motion of the sphere at the instant of release. A number of candidates stated that the path would be parabolic but this is true only in the time after release, not at the instant of release.

(a) Explain why, at the instant of release, the sphere stops travelling in a circular path.

(2)

Because the person stops applying a centripetal force to it so the hammer continues in a straight, tangent path to its original circular path.



ResultsPlus
Examiner Comments

A 2 mark answer.

(a) Explain why, at the instant of release, the sphere stops travelling in a circular path.

(2)

A centripetal force is required to travel in a circular path. At the instant of release, there is no more tension in the chain.



ResultsPlus
Examiner Comments

This scored 1 mark for no force at point of release. Saying a centripetal force is required for circular motion is not equivalent to referring to a force required for a change in direction.

Question 15 (b) (i)

A calculation with 68% of the candidates scoring both marks. The most common error was with units, many writing m s^{-1} or omitting the unit.

(i) Calculate the angular velocity of the sphere.

(2)

$$v = \omega r$$

$$18 = \omega (1.7)$$

$$\omega =$$

$$\text{Angular velocity} = 10.6 \text{ m s}^{-1}$$



ResultsPlus
Examiner Comments

Candidate uses wrong unit and so only scores 1 mark.



ResultsPlus
Examiner Tip

Candidates must take care of units. The unit for angular velocity is rad s^{-1}

Question 15 (b) (ii)

A well answered calculation where the most common mistake was confusing velocities. Some candidates used the linear velocity as an angular velocity or vice versa.

- (ii) Assuming that both the circle and chain are horizontal, calculate the force that the athlete exerts on the chain just before its release.

(2)

$$F = \frac{mv^2}{r} = \frac{7.3 \times 18^2}{1.7} = 13.9 \text{ N}$$

Force = 13.9 N



ResultsPlus
Examiner Comments

Equation correctly set up but there is a calculator error, so the response scores 1 mark.

QUESTION 1.1.11. The speed of the sphere, at the instant of release, is 18 ms⁻¹.

$$\omega = \frac{2\pi}{T}$$

(i) Calculate the angular velocity of the sphere.

$$v = \frac{2\pi r}{T}$$

$$\omega = \frac{v}{r} \quad (2)$$

$$\omega = \frac{2\pi}{T}$$

$$v = \frac{2\pi r}{T} \quad T = \frac{2\pi r}{v}$$

$$\omega = \frac{2\pi v}{2\pi r}$$

$$\omega = \frac{2\pi v}{2\pi r}$$

$$\omega = \frac{18 \text{ ms}^{-1}}{1.7}$$

$$\text{Angular velocity} = \underline{\underline{10.6 \text{ rad s}^{-1}}}$$

(ii) Assuming that both the circle and chain are horizontal, calculate the force that the athlete exerts on the chain just before its release.

(2)

$$F = \frac{mv^2}{r}$$

$$F = \frac{7.3 \times (10.6)^2}{1.7}$$

$$F = 482.48 \text{ N}$$

$$\text{Force} = \underline{\underline{482 \text{ N}}}$$



ResultsPlus Examiner Comments

This candidate uses the mv^2/r formula but uses the value of ω as v so scores no marks.

Question 15 (c) (i)

The adding of arrows to the diagram was used in order to help candidates when answering the next section. As expected it scored well, but 12% of the candidates did not score the mark. The mark was sometimes lost because we suspect that when answering the next section candidates added forces to the diagram as part of their workings. This lost them the mark.

(c) The diagram below shows the sphere moving in a vertical circle.

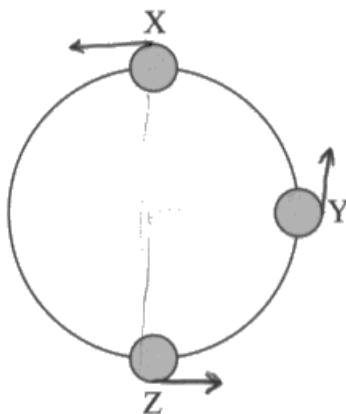

(i) Draw arrows on the diagram to show the direction of the centripetal force on the sphere at each of the positions X, Y and Z.

(1)

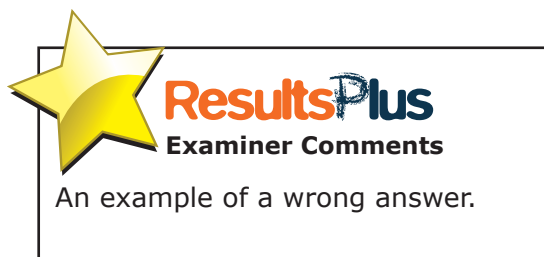

Question 15 (c) (ii)

In order to score full marks for this section candidates needed to make it clear that the two forces acting were the tension and weight and that it was the resultant of these two forces that provided the centripetal acceleration. This was an 'explain' type question with a quality of written communication, and although equations were expected and credited, full marks could not be awarded for equations alone. About a third of the candidates scored 3 marks, the missed mark being the one identifying the resultant force as centripetal. Candidates should not use F as the symbol for the centripetal force without defining it as such (since F is a generic symbol for force). 27% of the candidates scored zero because they thought the maximum tension was at the top X, so there was nothing they could write to justify this, hence no marks.

*(ii) The tension in the chain varies as the sphere moves in the vertical circle.

State the position, X, Y or Z, at which the tension will be a maximum and the position, X, Y or Z, where it will be a minimum. Explain your answers.

(4)

At X. The tension will be minimum.

$$\text{Because } T = m\frac{v^2}{r} - mg$$

At Z. The tension would be maximum.

$$\text{Because } T = m\frac{v^2}{r} + mg.$$



ResultsPlus
Examiner Comments

The minimum that needed to be written for 3 marks.



ResultsPlus
Examiner Tip

Take note of the * at the start of the question. More words are needed to score full marks.

*(ii) The tension in the chain varies as the sphere moves in the vertical circle.

State the position, X, Y or Z, at which the tension will be a maximum and the position, X, Y or Z, where it will be a minimum. Explain your answers.

(4)

Maximum: Z because at Z ~~T~~ T must be greater than W ~~so~~ in order to provide a centripetal net force $\frac{mv^2}{r}$ towards the centre;

Minimum: X because the resultant centripetal force $\frac{mv^2}{r}$ is ~~the sum of weight and tension~~ provided by the net force which is equal to the vector sum of T and W, and in this case $W > T$.



ResultsPlus Examiner Comments

An example that scores all four marks. Equations were not essential, it was the relative values of the forces that were required.

*(ii) The tension in the chain varies as the sphere moves in the vertical circle.

State the position, X, Y or Z, at which the tension will be a maximum and the position, X, Y or Z, where it will be a minimum. Explain your answers.

(4)

~~Max at Z and min at X~~

At X The tension in the string acts ~~towards~~ towards the center of the circle and so does the weight of the sphere. This means that This is where the Tension is the most.

At Z the tension and weights cancel out as they are in opposite directions. Hence the tension is the least at Z .



ResultsPlus
Examiner Comments

An answer that shows that the candidate does not understand what is happening in this situation. This scored zero.

Question 16 (a)

There were a considerable number of answers referring to a force of repulsion from the positive plate and a force of attraction for the negative plate. This was not credited. Having studied fields candidates should appreciate that in an electric field there is a single force acting on a charged particle. Very few candidates referred to the direction of the acceleration and there was hardly any mention of the constant horizontal velocity which was essential in order to explain a parabolic path. As a result, the marks of 0, 1 and 2 were achieved by about 25% of the candidates.

- 16 A beam of identical positive ions travels horizontally in a vacuum. The ions pass between two charged plates and are deflected downwards by the electric field between the plates.

The diagram shows the path of one of the ions.

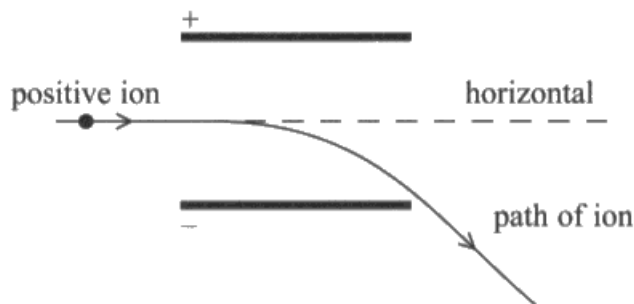

- *(a) Explain the path of the ion both between the plates and when it has left the plates.

(4)

As the ion is moving in the ^{electric} ~~magnetic~~ field, it experiences an electric force downwards, as the positive charge is attracted to the negative plate. As the electric force is a resultant force, the positive ion also accelerates towards the negative plate, causing the curvature of its path to decrease at horizontal velocity remains the same, but the vertical velocity increases. When the ion leaves the electric field, ~~it no longer experiences~~ ~~the electric force~~ ~~sto~~ the electric force, therefore there is no ~~net~~ resultant force acting on the particle. Due to this it continues to move with a constant velocity.



ResultsPlus
Examiner Comments

An example of an answer that scored 4 marks.

- 16 A beam of identical positive ions travels horizontally in a vacuum. The ions pass between two charged plates and are deflected downwards by the electric field between the plates.

The diagram shows the path of one of the ions.

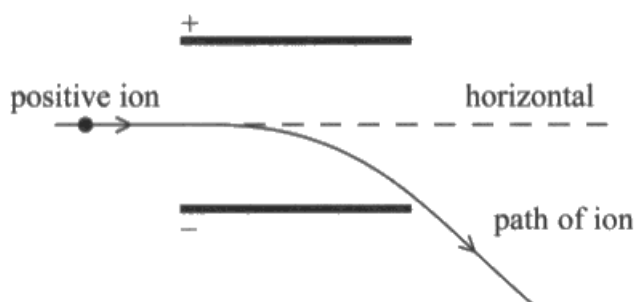

*(a) Explain the path of the ion both between the plates and when it has left the plates.

(4)

- when the ion is in the plates, it is subjected to an electric force due to effects of repulsion and attraction.
- so, the ion is deflected to the negative plate.
- when the ion leaves the plates, it is not subjected to any external forces and only has a horizontal velocity.
- So, the ~~ion~~ ion stops curving and travels in a straight path.



ResultsPlus
Examiner Comments

A typical answer that scores 2 marks. There is no reference to acceleration or the horizontal velocity.

- 16 A beam of identical positive ions travels horizontally in a vacuum. The ions pass between two charged plates and are deflected downwards by the electric field between the plates.

The diagram shows the path of one of the ions.

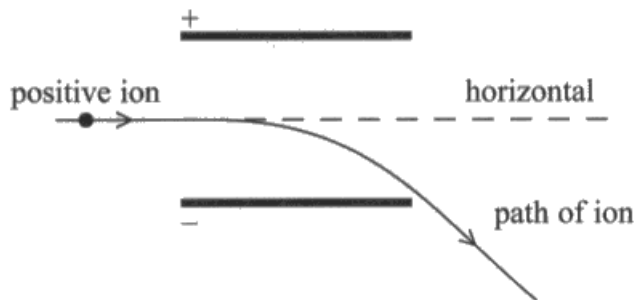

- *(a) Explain the path of the ion both between the plates and when it has left the plates.

(4)

When the ion is between the plates it moves ~~to~~ towards the negatively charged plate, because it is repelled by the positive plate and attracted by the negative plate. When the ion leaves the plates, the ion starts moving in a straight line but no longer ^{moving} horizontally. ~~it is deflected~~



ResultsPlus
Examiner Comments

An example of the repulsion and attraction type of answer that scored zero.

Question 16 (b) (i)

A lot of candidates were unable to differentiate between fields and forces and gave answers about the two fields needing to be equal. The clearest answer was that the electric and magnetic forces needed to be equal and in opposite directions. Some candidates tried to give the direction of the magnetic field which was an alternative method but had to be correct. Stating that the fields had to be perpendicular, whilst correct, was not specific enough to identify the correct field direction. Over 50% of the candidates scored zero.

(b) Whilst the electric field is still acting, the path of the ions can be returned to the horizontal by applying a magnetic field over the same region as the electric field acts.

(i) Explain the conditions under which the ions have no overall deflection as they pass between the plates.

(2)

If a magnetic field is directed into the paper, by Fleming's left hand rule, a magnetic force will act upwards on the positive ion. If this magnetic force is equal to the electric force, they will cancel out.

Therefore there won't be a resultant force on the ions. So it will move without deflection.



ResultsPlus
Examiner Comments

An answer that identifies the field direction and scores both marks.

(b) Whilst the electric field is still acting, the path of the ions can be returned to the horizontal by applying a magnetic field over the same region as the electric field acts.

(i) Explain the conditions under which the ions have no overall deflection as they pass between the plates.

(2)

The magnetic field strength must be equal to the electric field strength. The equal forces will keep the ions in equilibrium without deflection.



ResultsPlus
Examiner Comments

The statement that the field strengths had to be equal meant that this scored zero marks, even though there is a later reference to equal forces, since these are contradictory statements.

Question 16 (b) (ii)

Q16 was about the path of ions in magnetic and electric fields and nowhere was there any indication of the charge on the ion. This means that candidates could not make assumptions about the value of charge. Candidates were required to work with the data provided. They needed to equate a magnetic force and an electric force, both of which depend on the charge of the ion, to derive an equation that was independent of charge. Candidates who chose to assume a value of charge were limited to MP1 for the use of $E=V/d$. Nearly 40% of the candidates managed to score 4 marks with zero being the next most awarded mark.

- (ii) The ions have a velocity of 260 km s^{-1} . The plate separation is 4.5 cm and the potential difference across the plates is 60 V .

Calculate the magnetic flux density required so that there is no overall deflection of the ions.

(4)

~~$E = V/d$~~ $E = V/d$; $F = EQ$ $F = Bqv$

$$E = \frac{V}{d} = \frac{60}{0.045} = 1300 \text{ Vm}^{-1} \quad F_E = EQ$$
$$F_E = 1300 \cdot 1.6 \times 10^{-19} = 2.08 \times 10^{-16} \text{ N}$$

If no deflection: $Bqv = EQ$

$$B = \frac{EQ}{qv} = \frac{2.08 \times 10^{-16}}{1.6 \times 10^{-19} \cdot 260 \times 10^{-3}} = \cancel{5000} \text{ T} \quad 5000 \text{ T}$$

Magnetic flux density = $\cancel{5000} \text{ T}$ 5000 T



ResultsPlus
Examiner Comments

This answer has taken the charge to be e and so scores only 1 mark.

- (ii) The ions have a velocity of 260 km s^{-1} . The plate separation is 4.5 cm and the potential difference across the plates is 60 V .

Calculate the magnetic flux density required so that there is no overall deflection of the ions.

(4)

$$F = Bqv \quad ; \quad E = \frac{V}{d} \quad \Rightarrow \quad F = Eq$$

$$\therefore Eq = Bqv \quad ; \quad E = Bv \quad ; \quad E = \frac{V}{d}$$

$$\Rightarrow \frac{V}{d} = Bv \quad ; \quad \frac{60}{4.5 \times 10^{-2}} = B \times 260 \times 10^3$$

$$\Rightarrow B = 0.005 \text{ T} \approx \underline{\underline{5 \text{ mT}}}$$

Magnetic flux density = 5 mT



ResultsPlus
Examiner Comments

A well laid out answer that is clear to follow and scores 4 marks.

Question 16 (c)

40% of candidates scored 1 mark on this question, and 40% scored zero. The main reason why full marks were not awarded was because candidates made no reference to the path in the electric field despite the question asking for the differences between the two paths. Candidates did not seem to appreciate that the direction of the electric field remains constant whilst the direction of the magnetic field continually changes. Often answers were too vague to be given credit. When describing the magnetic force as being perpendicular to the velocity of the ions, they often said it was perpendicular to the direction of the particles. Direction is not a quantity so this did not get a mark. Direction of motion was acceptable, but not direction alone.

(c) State and explain how the path of the ions in just the magnetic field would be different from the path in just the electric field.

(3)
The path followed by ions in magnetic field only is circular,
as a magnetic field is applied perpendicular to the direction of
velocity of positive ion, ~~the~~ magnetic force acts at right angles
to the direction of velocity towards center, (that it is centripetal)
hence causing it travel in a circular path. (even though magnitude of velocity
is constant the direction changes as it travelling circular path hence it's accelerating)
But in an electric ~~field~~ ^{field}, only it will follow a parabolic pathway (parabola)



ResultsPlus
Examiner Comments

This scored 2 marks for the first 3 lines of the answer and the 3rd mark in the last line. Only 4% of candidates scored 3 marks.

(c) State and explain how the path of the ions in just the magnetic field would be different from the path in just the electric field.

(3)

In the magnetic field the ions would enter a circular path.
~~It is~~ This is because the force experienced in a magnetic field is always perpendicular to the displacement of the ion.
In the electric field the ion will curve towards a negative charge and continue on a straight path towards it.



ResultsPlus
Examiner Comments

This scores 1 mark for the idea of circular motion but the reference to displacement is wrong.

(c) State and explain how the path of the ions in just the magnetic field would be different from the path in just the electric field.

(3)

In the magnetic field, the magnetic force will act upwards. This will make the ion to upwards. Therefore this path will curve upwards, whereas in an electric field, the path ^{will} curve downwards.



ResultsPlus
Examiner Comments

Another 1 mark answer for the idea that the path will curve upwards.

Question 17(a) (i)

Many candidates, rather than adding to the circles on the power supply, chose to add + and - to the tubes. This showed the correct polarity, and was therefore acceptable. A significant number of candidates added nothing to the diagram thus losing out on a mark, while others labelled one tube positive and the other end of the same tube negative. Candidates could state that the field was from C to B, but if they answered in terms of repulsion and attraction they had to refer to both tubes and not just C.

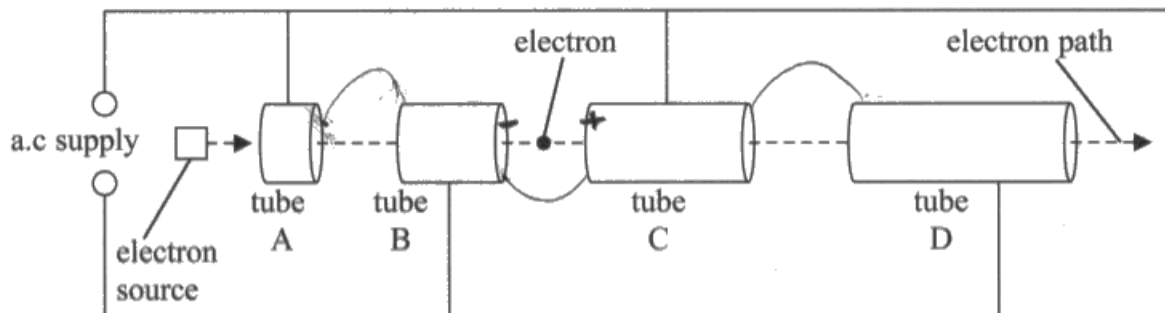

- (i) An electron is shown between tubes B and C.

The circles on the diagram indicate the terminals of the a.c. supply. Indicate on the diagram their polarity when the electron is between tubes B and C.

Explain your answer.

(2)

The electron accelerates in the gaps between the tubes. So due to the alternating current when the electron moves out of B, C becomes positive when B becomes negative, accelerating it into tube C.



ResultsPlus
Examiner Comments

This scored the diagram mark only. Stating that C was positive and D negative is just a repetition of what has been added to the diagram. Since the question was about particle accelerators there was no credit for merely referring to an acceleration.



ResultsPlus
Examiner Tip

Candidates should read the question carefully.

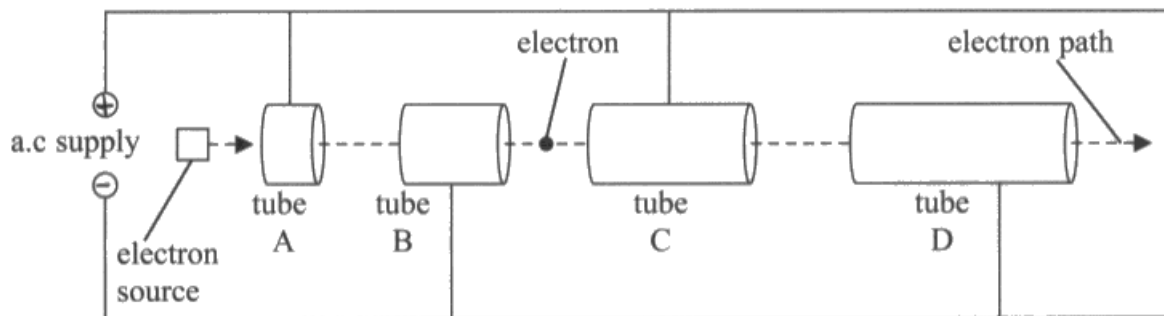

(i) An electron is shown between tubes B and C.

The circles on the diagram indicate the terminals of the a.c. supply. Indicate on the diagram their polarity when the electron is between tubes B and C.

Explain your answer.

(2)

to be able to provide a force on the electron
 According to Fleming's left hand rule this should
 be the setting



ResultsPlus
 Examiner Comments

Another one mark answer which explains why a field is necessary but not why the polarity is as shown.

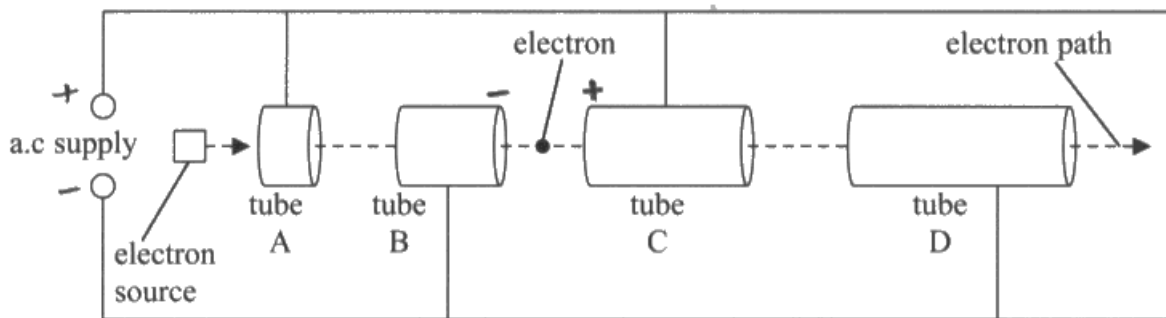

- (i) An electron is shown between tubes B and C.

The circles on the diagram indicate the terminals of the a.c. supply. Indicate on the diagram their polarity when the electron is between tubes B and C.

Explain your answer.

(2)

This is because tube B has to be negative to repel the electron so it does not come back and tube C has to be positive to attract the electron.



ResultsPlus
Examiner Comments

A 2 mark answer.

Question 17 (a) (ii)

Only 68% of candidates scored this mark.

(ii) Explain why it is necessary for the tubes to increase in length along the linac.

(1)

The electric field between tubes causes electrons to accelerate so tubes must increase in length so that electrons are the same amount of time in each tube.
- constant frequency

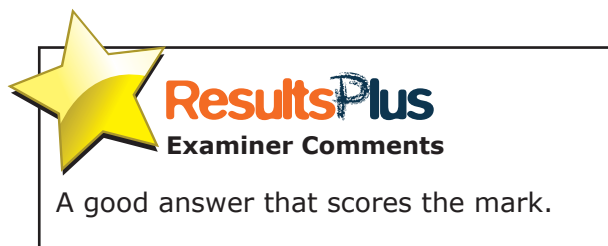

Question 17 (a) (iii)

A number of candidates did not take time to read the question carefully and so calculated the energy in one gap. This scored 1 mark and was awarded to 40% of the candidates. 22% of the candidates appreciated that the acceleration and gain in energy occurred in the gaps and so had a factor of 3 in their calculation and so scored the full 3 marks. Credit for 2 marks was given to candidates who used a factor of 4 since this showed an appreciation of the increase in energy in stages along the accelerator.

(iii) The peak voltage of the a.c. supply is 250 kV.

Calculate the increase in electron kinetic energy, in joules, as the electron moves from tube A to tube D.

(3)

$$W = QV \quad W = 250 \times 10^3 \times e = 250000 \times 1.6 \times 10^{-19} \\ = 4 \times 10^{-14} \text{ J}$$

$$4 \times 10^{-14} \times 3 = 1.2 \times 10^{-13} \text{ J}$$

$$\text{Increase in kinetic energy} = 1.2 \times 10^{-13} \text{ J}$$



ResultsPlus
Examiner Comments

A correct answer for 3 marks.

(iii) The peak voltage of the a.c. supply is 250 kV.

Calculate the increase in electron kinetic energy, in joules, as the electron moves from tube A to tube D.

(3)

$$Kf = eV \\ = 1.6 \times 10^{-19} \times 250 \times 10^3 \\ = 4 \times 10^{-14} \text{ J}$$

$$\text{Increase in kinetic energy} = 4 \times 10^{-14} \text{ J}$$



ResultsPlus
Examiner Comments

The common wrong answer where the energy for one gap is found, scores 1 mark.

Question 17 (b) (i)

Those candidates who understood the nature of matter and antimatter were able to score this mark. Both particles needed to be correct for the mark to be awarded. Three quarters of the candidates scored the mark.

The diagram is a representation of a hydrogen atom and an anti-hydrogen atom.

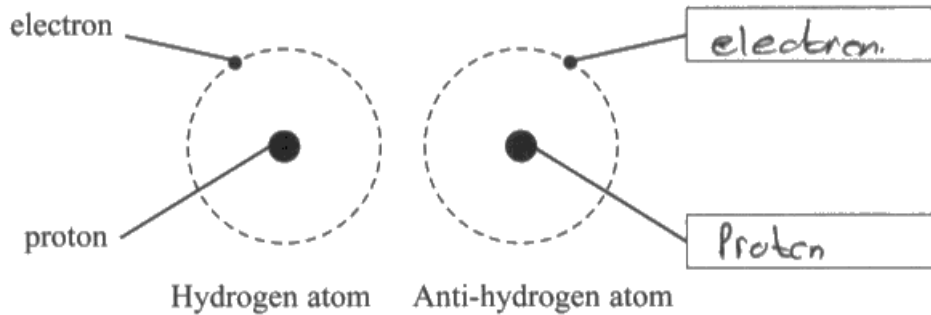

(i) Use the boxes in the diagram to identify the particles in the anti-hydrogen atom.

(1)

ResultsPlus
Examiner Comments

An example of the matter names being used.

Question 17(b) (ii)

This was generally well answered with 65% scoring both marks. The most common error was to say that the charges were different rather than opposite. Different charges could mean different magnitude or polarity so this is not sufficient for the mark.

- (ii) State one difference and one similarity between the electron and its corresponding particle in the anti-hydrogen atom.

(2)

Charge is different but mass is the same.



ResultsPlus
Examiner Comments

An example of the use of the word 'different'.

- (ii) State one difference and one similarity between the electron and its corresponding particle in the anti-hydrogen atom.

(2)

- both are antimatter

- both ~~are~~ have different mass.



ResultsPlus
Examiner Comments

Another way in which candidates demonstrate a lack of understanding of matter and antimatter.

Question 17 (b) (iii)

The idea of annihilation was required and since the command word was stated, that was the answer required. 73% of the candidates scored this mark.

Question 17 (c) (i)

This question part was poorly answered because candidates did not appreciate that all charge is defined in terms of the charge on the electron and not the charge on the proton. Also the command word was 'explain' and not just 'write'. Candidates were required to use the word 'positive' or say that it was the opposite charge to the electron. Because it was an 'explain' question, any symbol used had to be defined.

The most common answer was 'it is 2/3 the charge of the proton'. This scored zero which was the mark given to 66% of the candidates.

(i) Explain what is meant by a charge of +2/3.

(2)

+2/3 means +2/3 of ^{proton}~~electron~~ charge
 $+2/3 e$ or $+2/3 \times 1.6 \times 10^{-19} = +1.07 \times 10^{-19} \text{ C}$



ResultsPlus
Examiner Comments

This scored zero because the 'e' has not been defined.

(i) Explain what is meant by a charge of +2/3.

(2)

It is the charge relative to a charge of electron. Since electron has -1 charge, +2/3 charge means opposite charge of electron times 2/3.



ResultsPlus
Examiner Comments

An example that scored 2 marks.

(i) Explain what is meant by a charge of $+2/3$.

(2)

It means that the charge is positive and it
(two third) is $\frac{2}{3}$ of the charge of a proton. ~~the~~.



ResultsPlus
Examiner Comments

A 1 mark answer for the use of the word positive.

Question 17 (c) (ii)

Because of what was asked in (c)(i) the unit e was omitted from the table. Candidates needed to use the table to decide in their answers for the mass and charge of the quark and so the units of mass were expected in the answer, since they were in the table. There was no requirement for the e to be added to the value of charge. Candidates should have written the words 'mass' and 'charge' to identify which of the values related to those quantities. If the words were omitted, it was assumed that the first number written down was the mass since that was asked for first in the question.

(ii) State the predicted mass and charge of the \bar{u} quark.

(2)

$$\text{Charge} = -\frac{2}{3}$$

$$\text{Mass} = \frac{4 \text{ MeV}}{c^2}$$



ResultsPlus

Examiner Comments

A fully correct answer with the quantities identified.

(ii) State the predicted mass and charge of the \bar{u} quark.

(2)

$$\text{mass of } \bar{u} = 4$$

$$\text{charge of } \bar{u} = -2/3$$



ResultsPlus

Examiner Comments

No unit for mass so 1 mark only.

(ii) State the predicted mass and charge of the \bar{u} quark.

(2)

$-\frac{2}{3}$, 4



ResultsPlus
Examiner Comments

No words, so first value taken as the answer for the mass. This scored zero.



ResultsPlus
Examiner Tip

If you are asked for two quantities it is sensible to state which one is which.

Question 17 (c) (iii)

This is a standard unit conversion that proved challenging for less able candidates. The most common errors were to fail to square the value c , to divide and later multiply by c^2 and to divide by e and multiply by c^2 .

(iii) Calculate the mass of the \bar{s} quark in kg.

(3)

$$\text{mass} = \frac{80 \times 10^6 \times 1.6 \times 10^{-19}}{(3 \times 10^8)^2} = 1.42 \times 10^{-28} \text{ kg}$$
$$= 1.4 \times 10^{-28} \text{ kg}$$

$$\text{Mass} = 1.4 \times 10^{-28} \text{ kg}$$



ResultsPlus
Examiner Comments

A model answer for 3 marks.

(iii) Calculate the mass of the \bar{s} quark in kg.

$$c^2 = 9 \times 10^{16}$$

(3)

$$80 \times (9 \times 10^{16}) = 7.2 \times 10^{18} \text{ MeV}$$
$$(7.2 \times 10^{18}) \times 10^6 \times 1.6 \times 10^{-19} = 1152000$$
$$1152000 \div 9 \times 10^{16} = 1.28 \times 10^{-11} \text{ kg}$$

$$\text{Mass} = 1.28 \times 10^{-11} \text{ kg}$$



ResultsPlus
Examiner Comments

This candidate has multiplied by c^2 as well as by e . Scores 1 mark.

(iii) Calculate the mass of the \bar{s} quark in kg.

(3)

$$= \frac{4 \times (10^6 \times 1.60 \times 10^{-19} \text{ J})}{(3 \times 10^8)^2}$$

$$= \frac{6.4 \times 10^{-13}}{9 \times 10^{16}} = 7.11 \times 10^{-30} \text{ kg}$$

Mass = 7.11×10^{-30} kg



ResultsPlus
Examiner Comments

This candidate multiplies by e and divided by c^2 but goes on to divide by c^2 again. Scores 1 mark.

Paper Summary

Based on their performance on this paper, candidates should:

- Use words in calculations to explain what they are calculating. They should not just write a series of numbers.
- Answer in terms of the context and not in general terms (in context questions).
- Read the question carefully and look for instructions when they are asked to add to the diagram.
- When writing descriptive answers candidates should use short sentences and check that the subject of the sentence is clear.
- Look at the command words. 'State' means the candidates need not write too much, and that often only one word is needed. 'Explain' means 'mainly words', and any symbols used require definition.

Grade Boundaries

Grade boundaries for this, and all other papers, can be found on the website on this link:

<http://www.edexcel.com/iwantto/Pages/grade-boundaries.aspx>

Ofqual



Llywodraeth Cynulliad Cymru
Welsh Assembly Government



Pearson Education Limited. Registered company number 872828
with its registered office at 80 Strand, London WC2R 0RL.